



**METALOUMIN**

ΣΥΣΤΗΜΑΤΑ ΑΛΟΥΜΙΝΙΟΥ ΑΠΟ ΤΟ 1969



**EVRO 7000**

**Συρόμενα - Sliding**

EVRO 7000



**METALOU MIN**

**ΣΥΣΤΗΜΑΤΑ ΑΛΟΥΜΙΝΙΟΥ ΑΠΟ ΤΟ 1969**

**ΠΕΡΙΕΧΟΜΕΝΑ**

*Συνοπτικός Κατάλογος - Catalogue Overview*

*Προφίλ 1:1 - Profiles 1:1*

*Τομές - Sections*

*Κατεργασίες & Κατασκευαστικές Λεπτομέρειες - Milling & Construction Details*











*Γωνίες Συνδέσεως- Corner Joints-Alignment Corners*

*Μέτρα Κοπής - Cutting Calculations*



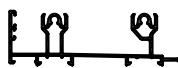



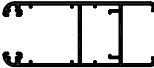
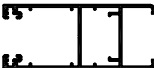



*Εξαρτήματα - Accessories*

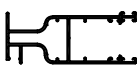
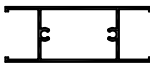

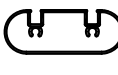









*Πολυπρέσα - Punching Machine*

## ΣΥΝΟΠΤΙΚΟ Summary

ΚΩΔΙΚΟΣ Code	ΣΧΗΜΑ Shape	ΒΑΡΟΣ gr/m Weight gr/m	ΠΕΡΙΓΡΑΦΗ Description	ΜΗΚΟΣ Length	Ix, Iy values
7170		572	ΜΟΝΟΣ ΟΔΗΓΟΣ Single rail	6	$I_x=1.85\text{cm}^4$ $I_y=3.34\text{cm}^4$
7171		1035	ΔΙΠΛΟΣ ΟΔΗΓΟΣ Double rail	6	$I_x=3,43\text{cm}^4$ $I_y=32.4\text{cm}^4$
7172		1451	ΤΡΙΠΛΟΣ ΟΔΗΓΟΣ (Επάλληλο με σήτα) (Τζάμι-σήτα-πατζούρι) Triple rail	6	$I_x=3,54\text{cm}^4$ $I_y=3,54\text{cm}^4$
7173		1496	ΤΡΙΠΛΟΣ ΟΔΗΓΟΣ ΕΠΑΛΛΗΛΟΥ Triple rail	6	$I_x=4.86\text{cm}^4$ $I_y=85.6\text{cm}^4$
7174		494	ΠΡΟΣΘΕΤΟΣ ΟΔΗΓΟΣ Additional rail	6	$I_x=1.54\text{cm}^4$ $I_y=3\text{cm}^4$
7180		578	ΜΟΝΟΣ ΟΔΗΓΟΣ ΙΝΟΧ Single rail with inox cap	6	$I_x=1.65\text{cm}^4$ $I_y=3.37\text{cm}^4$
7181		1037	ΔΙΠΛΟΣ ΟΔΗΓΟΣ ΙΝΟΧ Double rail with inox cap	6	$I_x=2.98\text{cm}^4$ $I_y=32.4\text{cm}^4$
7182		1449	ΤΡΙΠΛΟΣ ΟΔΗΓΟΣ ΙΝΟΧ (Επάλληλο με σήτα) (Τζάμι-σήτα-πατζούρι) Triple rail with inox cap	6	$I_x=4.9\text{cm}^4$ $I_y=85.6\text{cm}^4$
7183		1497	ΤΡΙΠΛΟΣ ΟΔΗΓΟΣ ΙΝΟΧ ΕΠΑΛΛΗΛΟΥ Triple rail with inox cap	6	$I_x=4.29\text{cm}^4$ $I_y=107.5\text{cm}^4$
7184		491	ΠΡΟΣΘΕΤΟΣ ΟΔΗΓΟΣ ΙΝΟΧ Additional rail with inox cap	6	$I_x=1.23\text{cm}^4$ $I_y=3.05\text{cm}^4$
7258		1006	ΦΥΛΛΟ ΠΟΜΠΕ Sash	6	$I_x=21.9\text{cm}^4$ $I_y=8\text{cm}^4$
7259		1031	ΦΥΛΛΟ ΙΣΙΟ Sash	6	$I_x=23.4\text{cm}^4$ $I_y=8.28\text{cm}^4$

## ΣΥΝΟΠΤΙΚΟ Summary

ΚΩΔΙΚΟΣ code	ΣΧΗΜΑ shape	ΒΑΡΟΣ gr/m weight gr/m	ΠΕΡΙΓΡΑΦΗ description	ΜΗΚΟΣ length	Ιx,ly values
7260		1164	ΦΥΛΛΟ ΠΟΜΠΕ ΜΕΓΑΛΟ Sash	6	$I_x=33.3\text{cm}^4$ $I_y=9.4\text{cm}^4$
7261		1194	ΦΥΛΛΟ ΙΣΙΟ ΜΕΓΑΛΟ Sash	6	$I_x=35.7\text{cm}^4$ $I_y=9.7\text{cm}^4$
7270		767	ΦΥΛΛΟ ΣΗΤΑΣ Insect screen sash	6	$I_x=13.5\text{cm}^4$ $I_y=2.75\text{cm}^4$
7371		858	ΔΙΑΧΩΡΙΣΤΙΚΗ ΤΡΑΒΕΡΣΑ ΜΕΓΑΛΗ Transom	6	$I_x=16.5\text{cm}^4$ $I_y=4.8\text{cm}^4$
7373		581	ΔΙΑΧΩΡΙΣΤΙΚΗ ΤΡΑΒΕΡΣΑ ΜΙΚΡΗ Transom	6	$I_x=2.53\text{cm}^4$ $I_y=3.78\text{cm}^4$
7375		709	ΔΙΑΧΩΡΙΣΤΙΚΗ ΤΡΑΒΕΡΣΑ ΣΗΤΑΣ Transom for mosquito screen frame	6	
7634		465	ΜΠΙΝΙ ΑΝΤΙΚΡΥΣΤΩΝ ΦΥΛΛΩΝ Adaptor for opposite sashes	4,60	$I_x=3.7\text{cm}^4$ $I_y=0.6\text{cm}^4$
7636		213	ΜΠΙΝΙ ΑΝΤΙΚΡΥΣΤΩΝ ΦΥΛΛΩΝ ΣΗΤΑΣ Adaptor for opposite insect screen sashes	4,60	$I_x=0.17\text{cm}^4$ $I_y=0.41\text{cm}^4$
7640		415	ΓΑΝΤΖΟΣ ΓΙΑ ΤΑ ΠΡΟΦΙΛ 7258, 7259 Hook for 7258, 7259 profiles	4,60	$I_x=4.46\text{cm}^4$ $I_y=0.99\text{cm}^4$
7641		466	ΓΑΝΤΖΟΣ ΓΙΑ ΤΑ ΠΡΟΦΙΛ 7260, 7261 Hook for 7260, 7261 profiles	4,60	$I_x=5.8\text{cm}^4$ $I_y=1.1\text{cm}^4$
7532		508	ΑΡΜΟΚΑΛΥΠΤΡΟ Closure for in the wall doors or windows	6	
7533		442	ΑΡΜΟΚΑΛΥΠΤΡΟ Closure for in the wall doors or windows	6	

ΚΩΔΙΚΟΣ code	ΣΧΗΜΑ shape	ΒΑΡΟΣ gr/m weight gr/m	ΠΕΡΙΓΡΑΦΗ description	ΜΗΚΟΣ length
7534		501	ΑΡΜΟΚΑΛΥΠΤΡΟ Closure for in the wall doors or windows	6
7535		250	ΑΡΜΟΚΑΛΥΠΤΡΟ ΚΟΥΜΠΩΤΟ ΜΙΚΡΟ Wall closure	6
7536		389	ΑΡΜΟΚΑΛΥΠΤΡΟ ΚΟΥΜΠΩΤΟ ΜΕΓΑΛΟ Wall closure	6
7537		324	ΑΡΜΟΚΑΛΥΠΤΡΟ Wall closure	6
8506		285	ΑΡΜΟΚΑΛΥΠΤΡΟ ΚΟΥΜΠΩΤΟ ΜΙΚΡΟ Wall closure	6
7538		209	ΝΕΡΟΣΤΑΛΑΚΤΗΣ ΟΔΗΓΩΝ	6
7750		82	ΚΑΠΑΚΙ ΟΔΗΓΩΝ ΙΝΟΧ Aluminum cap	6
7752		153	ΚΑΠΑΚΙ ΑΡΜΟΚΑΛΥΠΤΡΟΥ 7532 Cap for closure 7532	6
7754		137	ΚΑΠΑΚΙ ΑΡΜΟΚΑΛΥΠΤΡΟΥ 7534 Cap for closure 7534	6
7756		236	ΠΡΟΣΘΗΚΗ ΣΗΤΑΣ ΓΙΑ ΒΟΥΡΤΣΑΚΙ Adaptor for mosquito screen frame	6
8701		250	ΠΡΟΣΘΗΚΗ ΓΙΑ ΜΟΝΟ ΤΖΑΜΙ Adaptor for single glass	6
SL-81		1056	ΣΤΟΠΕΡ ΑΝΤΙΚΡΥΣΤΩΝ ΦΥΛΛΩΝ Stoprer for opposite sashes	6



ΠΡΟΦΙΛ 1:1  
profiles 1:1

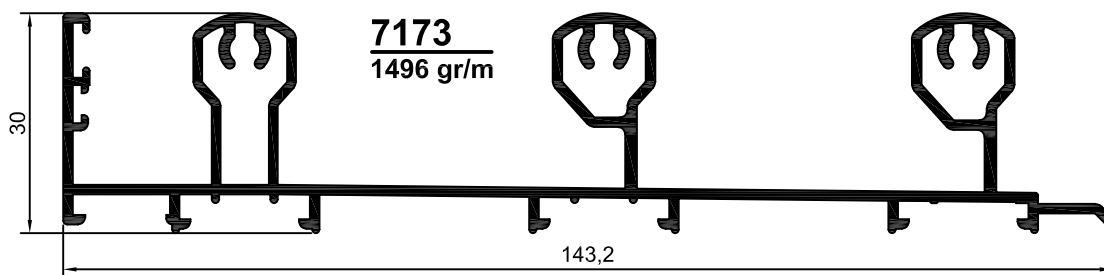
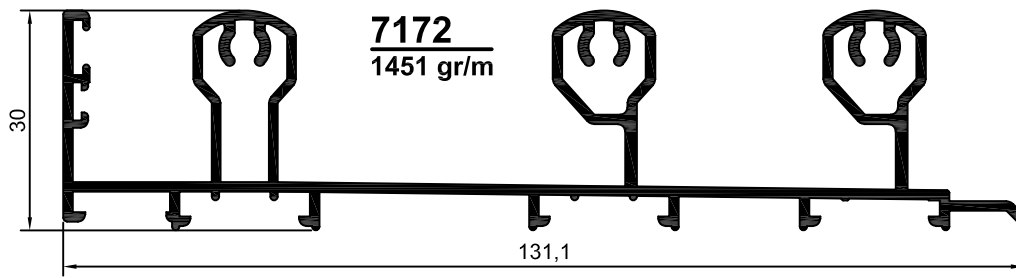
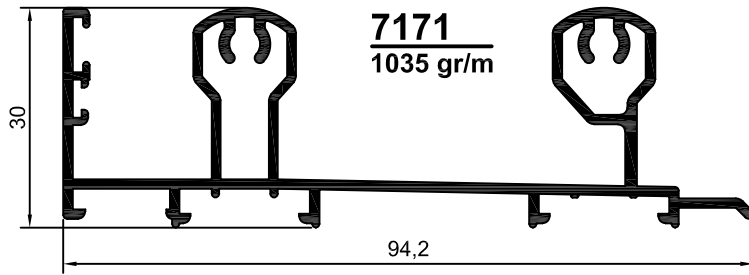
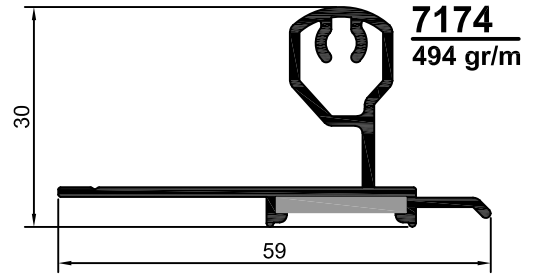
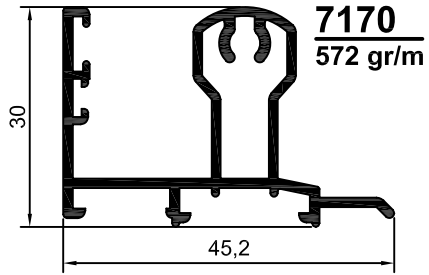

**ΠΡΟΦΙΛ 1:1**  
profiles 1:1

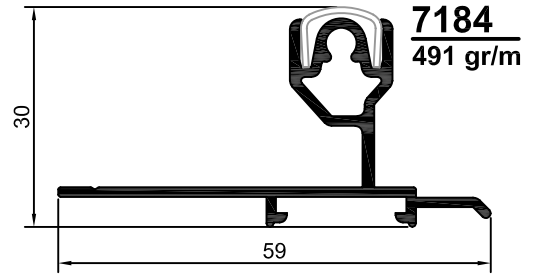
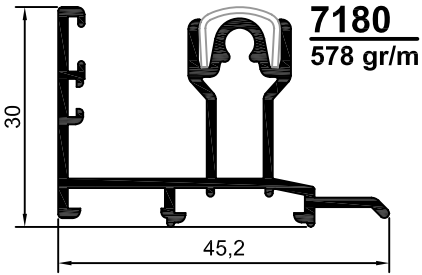

**ΛΑΜΑΚΙ INOX**  
inox cap

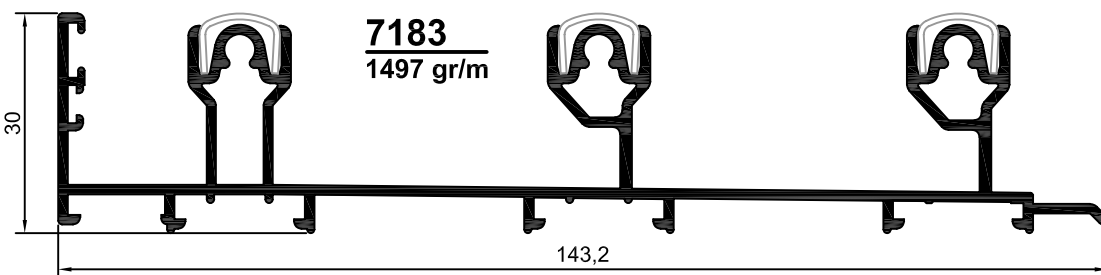
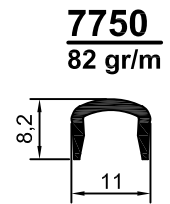
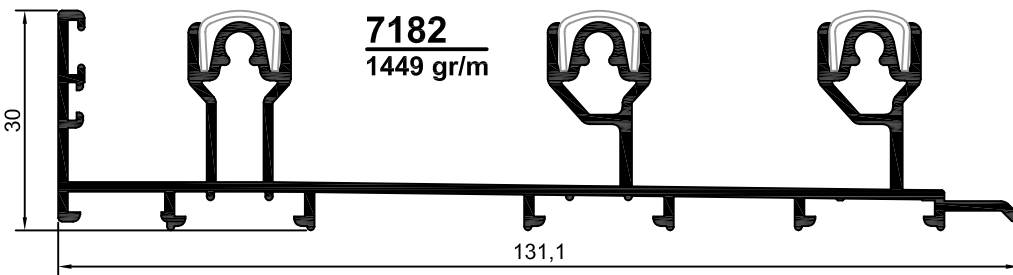
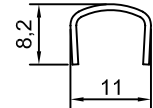
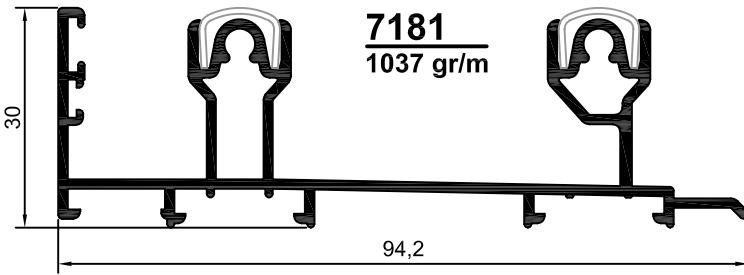



ΠΡΟΦΙΛ 1:1  
profiles 1:1

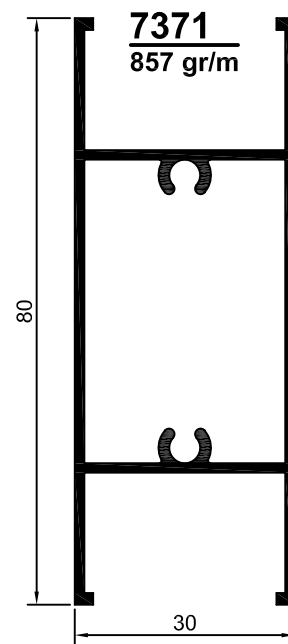
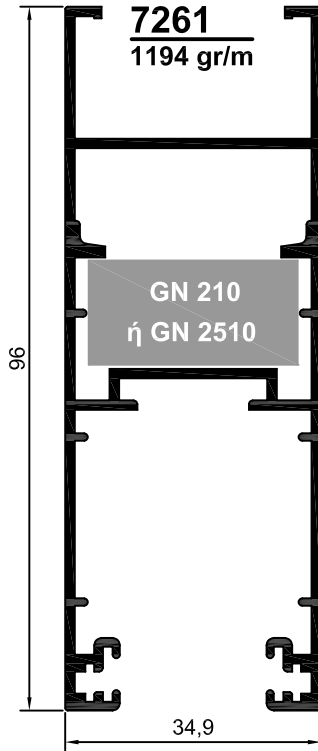
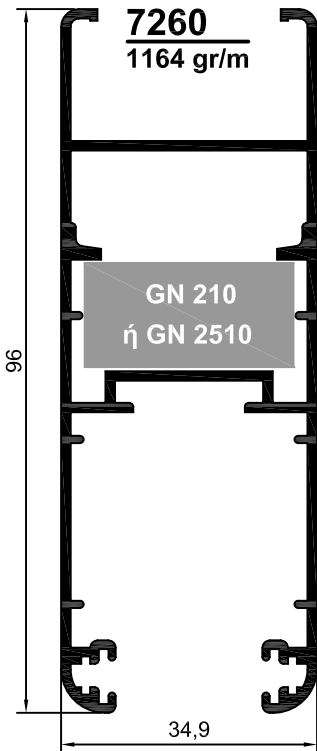
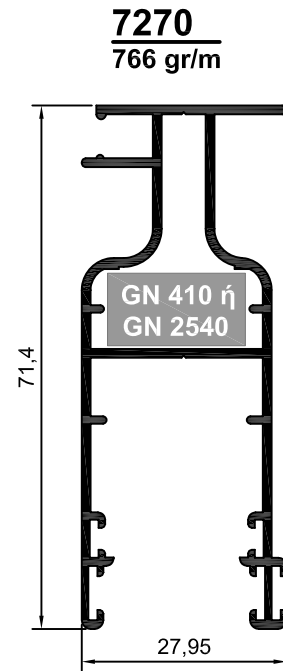
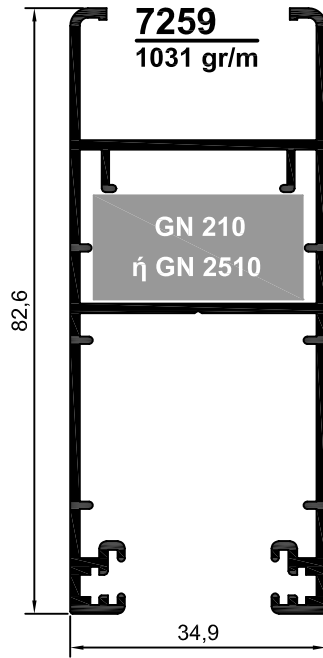
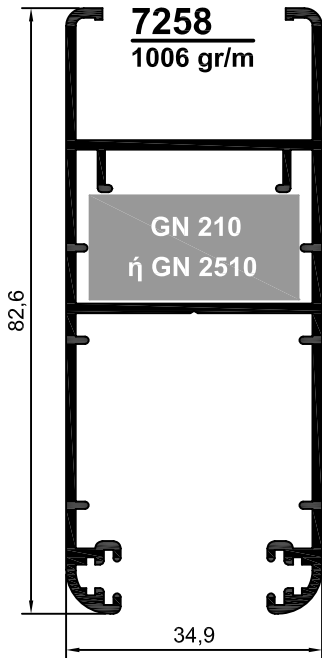





ΠΡΟΦΙΛ 1:1  
profiles 1:1

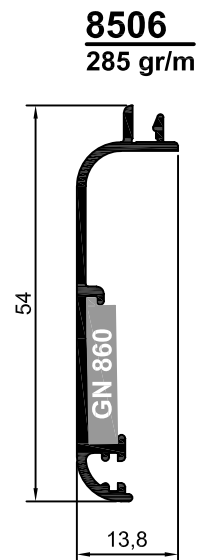
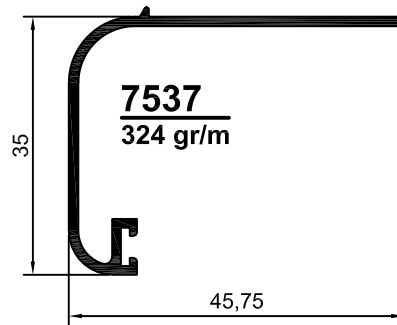
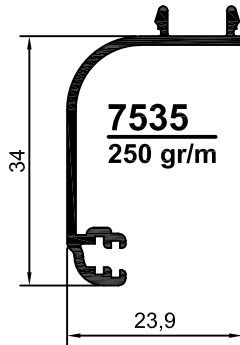
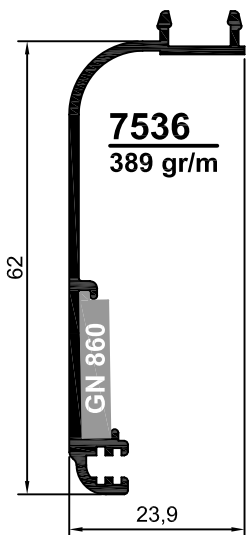
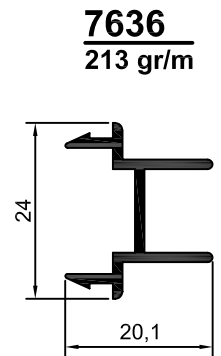
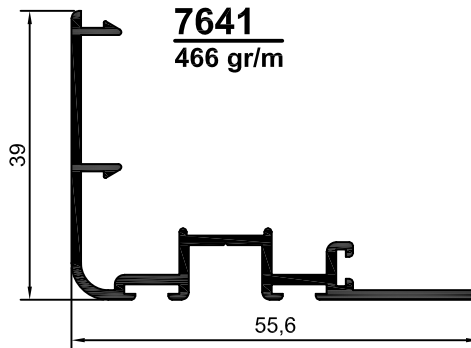
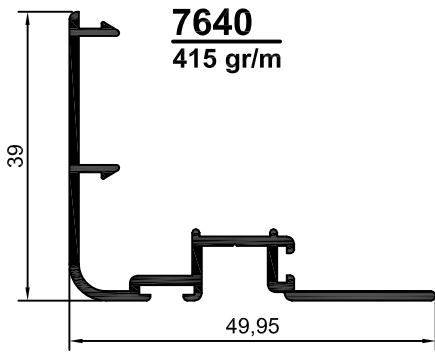
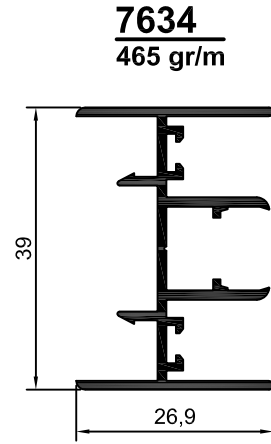
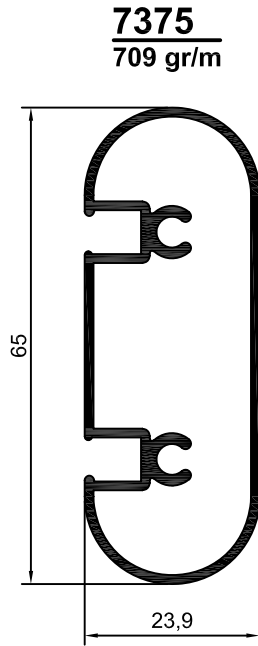
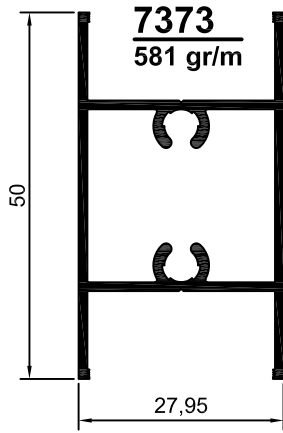



ΠΡΟΦΙΛ 1:1  
profiles 1:1

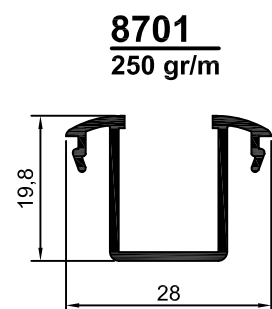
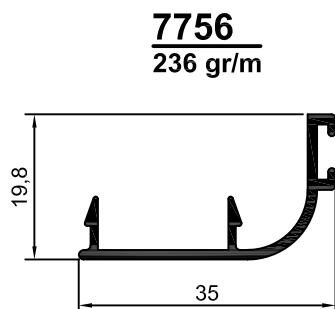
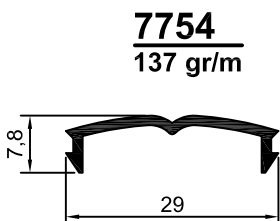
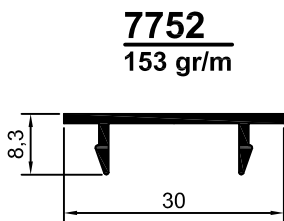
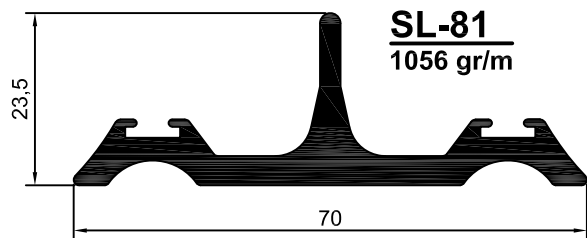
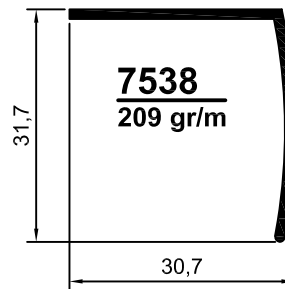
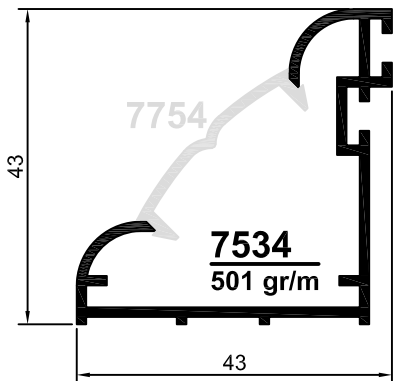
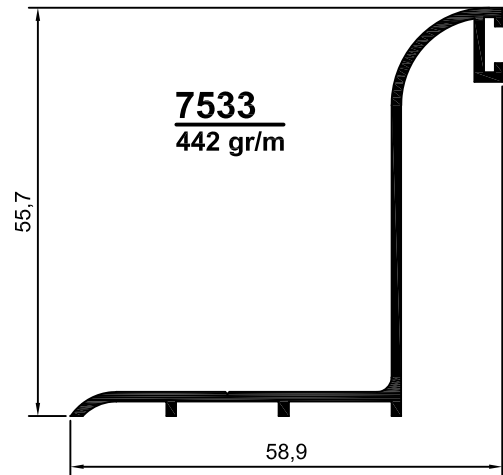
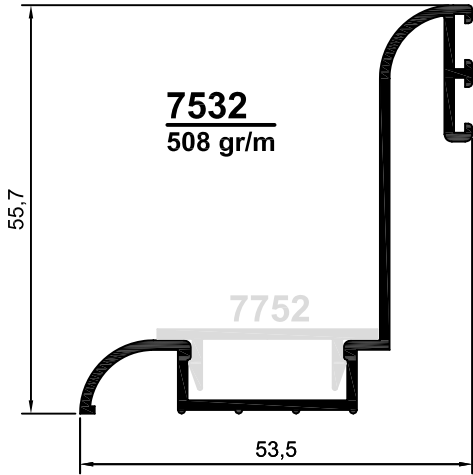



ΠΡΟΦΙΛ 1:1  
profiles 1:1

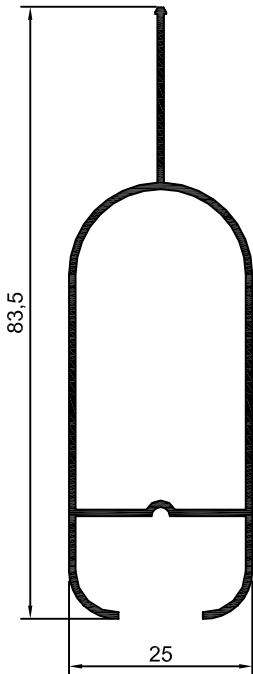

**25520**  
456 gr/m

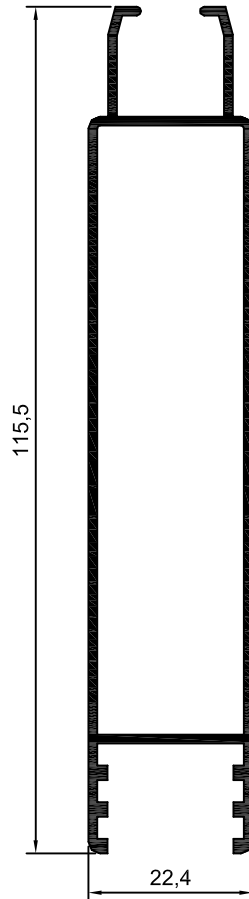

**25351**  
933 gr/m

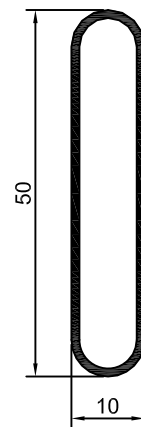

**10x50**  
322 gr/m

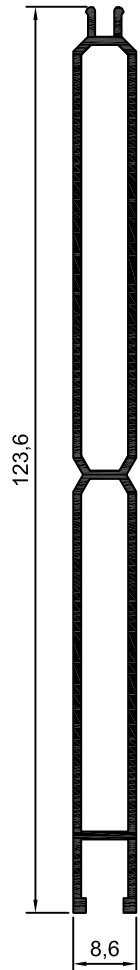

**9700**  
790 gr/m

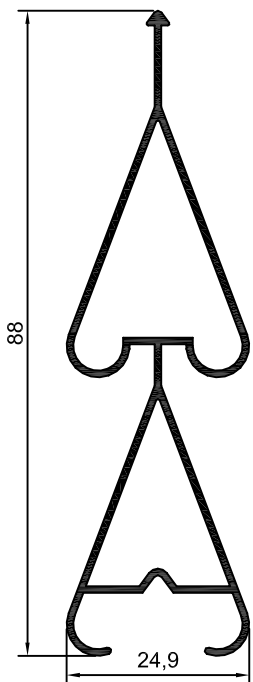

**25521A**  
563 gr/m

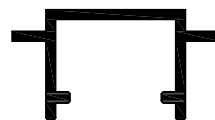

**7772**  
211 gr/m



**7771**  
170 gr/m

**ΔΙΦΥΛΛΟ ΕΠΑΛΛΗΛΟ**  
**DOUBLE SASH OVERLAPPING**

Sections Scale 1:1

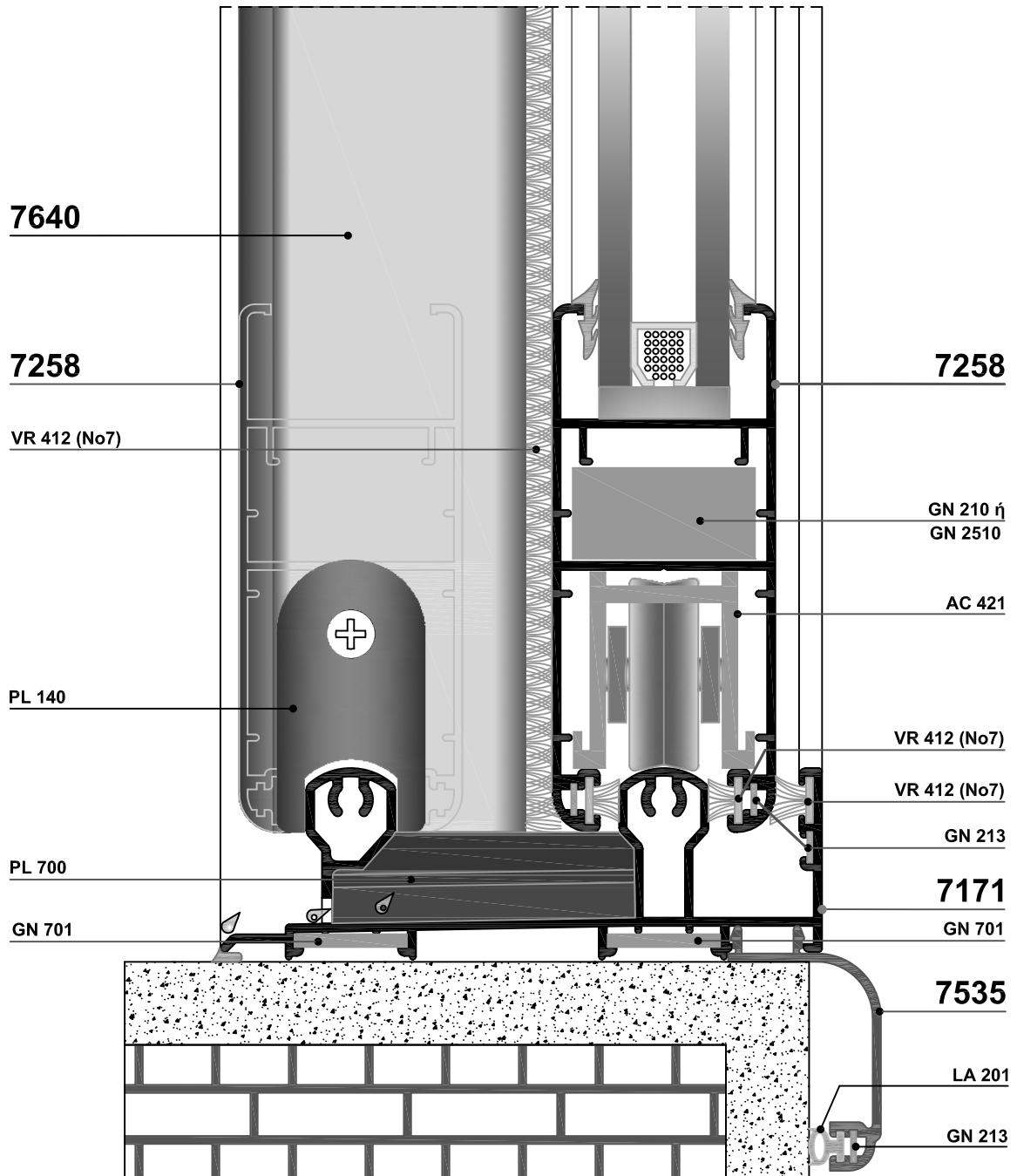
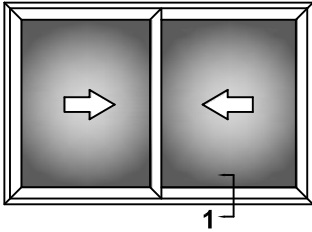

## ΔΙΦΥΛΛΟ ΕΠΑΛΛΗΛΟ DOUBLE SASH OVERLAPPING

Sections | Scale 1:1

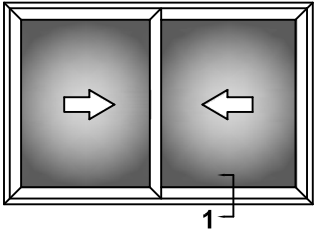

### ΜΕΣΑ

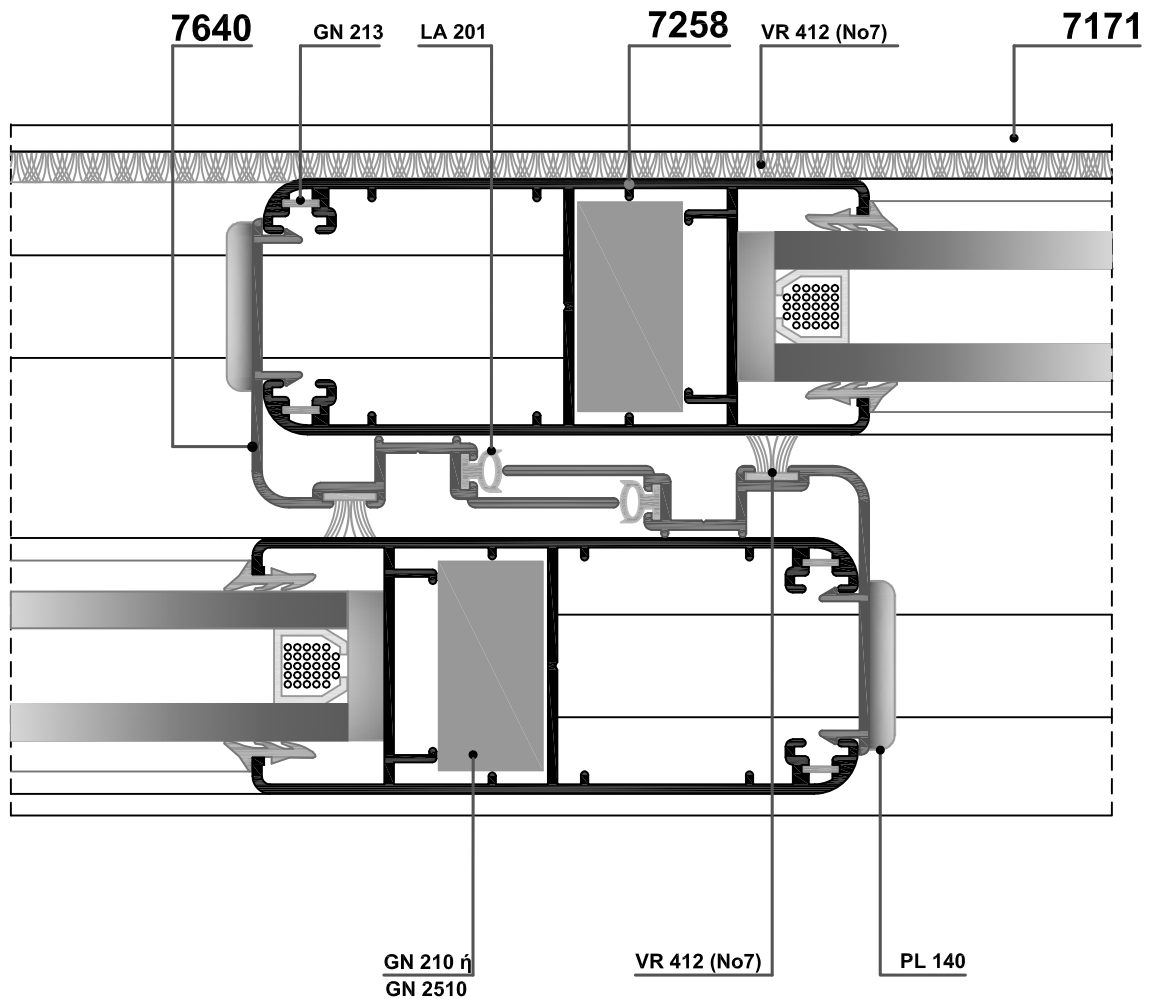

### ΕΞΩ

## ΔΙΦΥΛΛΟ ΕΠΑΛΛΗΛΟ ΜΕ ΣΗΤΑ

Double sash overlapping  
with insect screen

Sections Scale 1:1

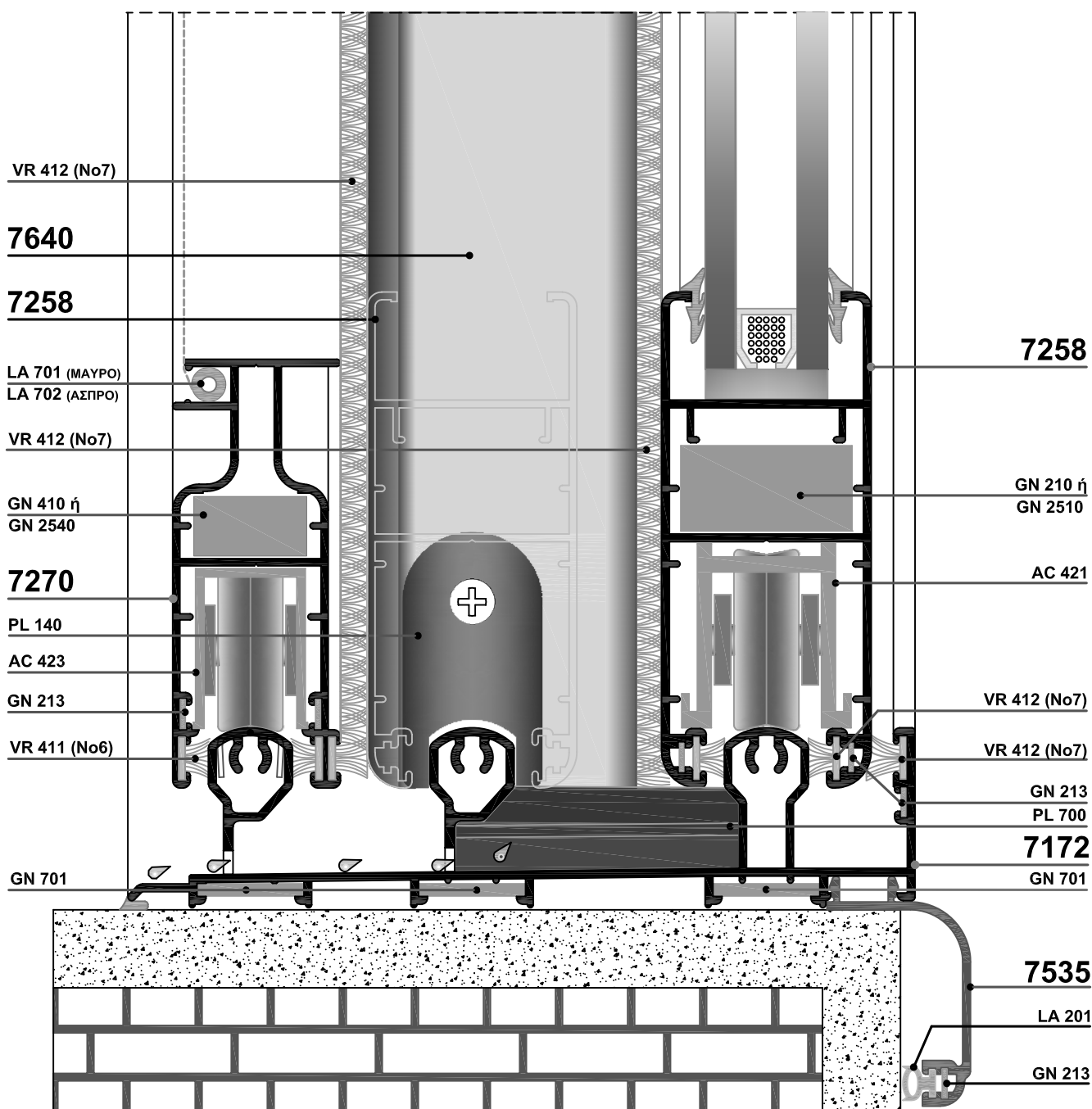
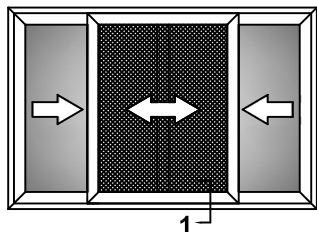



## ΤΖΑΜΙ - ΠΑΤΖΟΥΡΙ ΧΩΝΕΥΤΑ Glazing - shutter flushed in the wall

Sections Scale 1:1

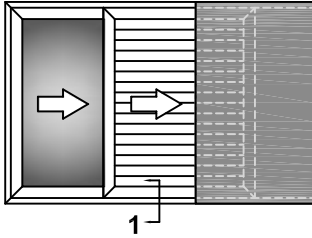

### TOMH 1 section 1

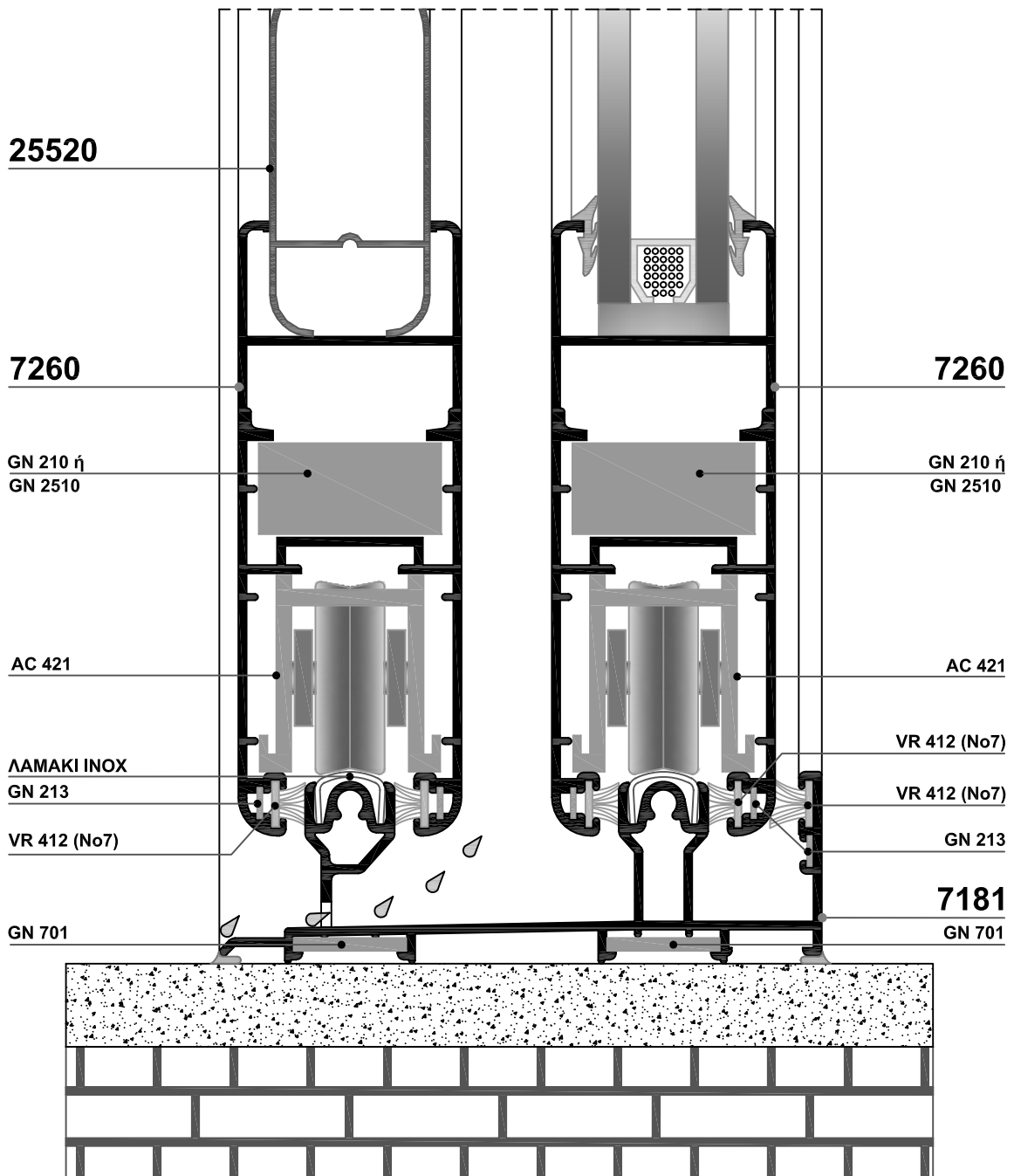

**ΤΖΑΜΙ - ΣΗΤΑ - ΠΑΤΖΟΥΡΙ ΧΩΝΕΥΤΑ**  
**Glazing - insect screen - shutter**  
**flushed in the wall**

**Sections** | **Scale 1:1**

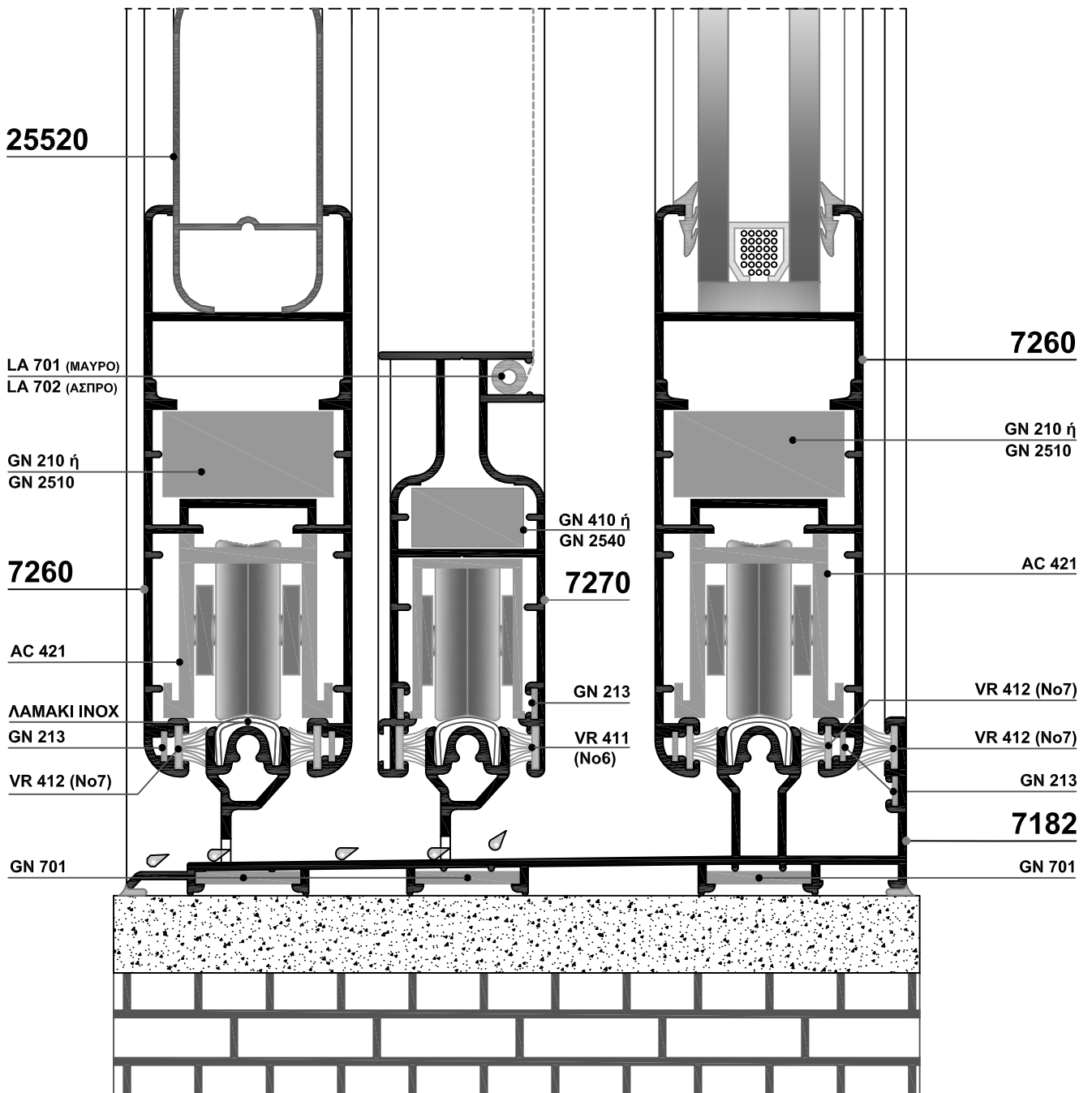
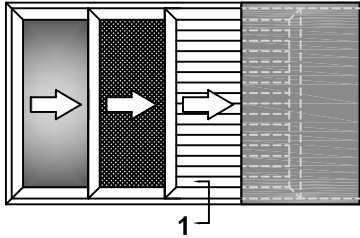



## ΤΖΑΜΙ - ΣΗΤΑ - ΠΑΤΖΟΥΡΙ ΑΝΤΙΚΡΙΣΤΑ ΧΩΝΕΥΤΑ

Flushed in the wall Glazing -Insect Screen- Shutter

Sections Scale 1:1

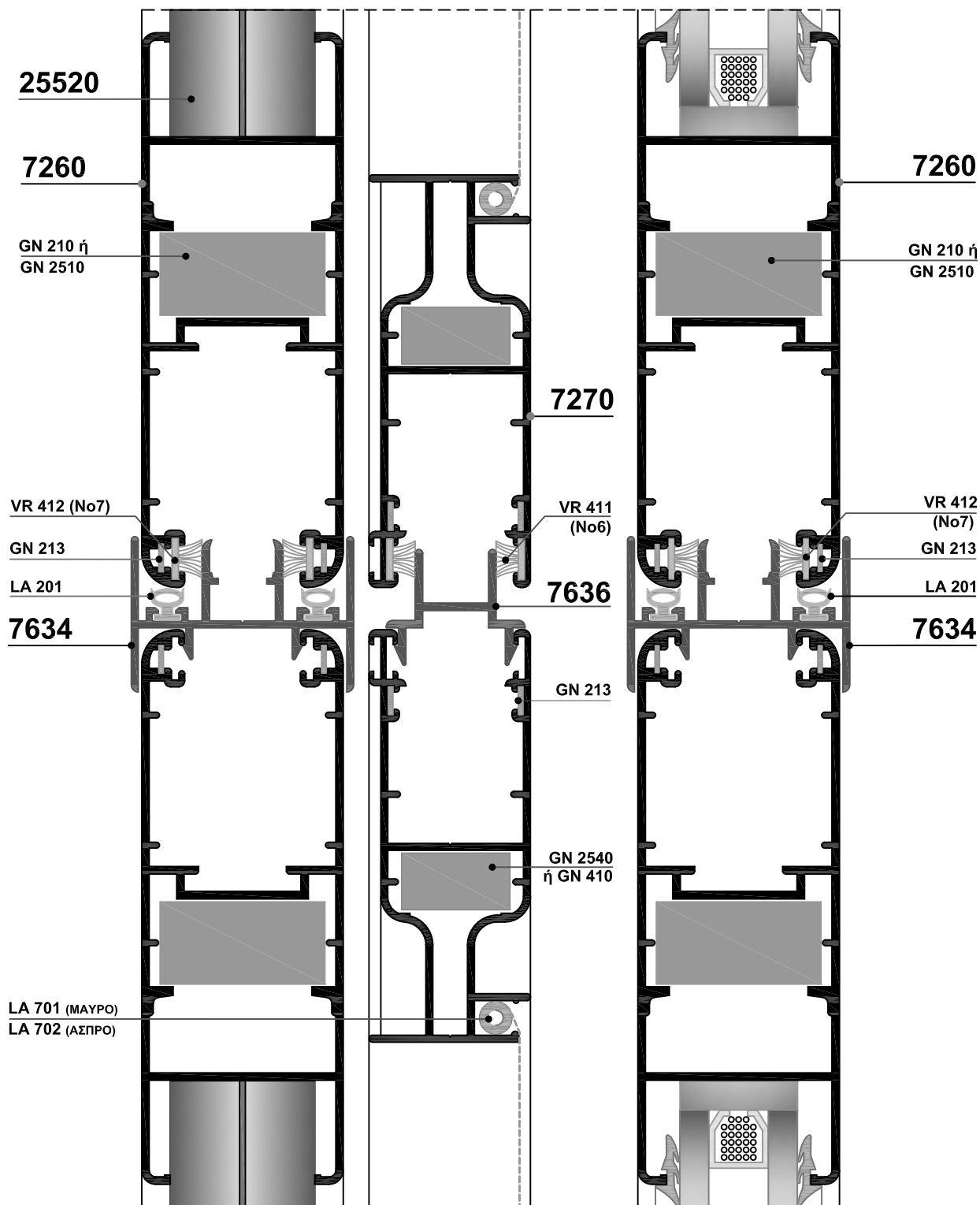
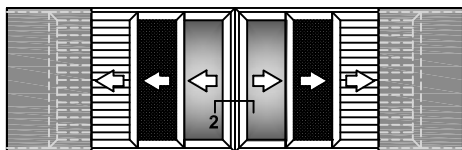

## TZAMI - ΣΗΤΑ - ΠΑΤΖΟΥΡΙ ΑΝΤΙΚΡΙΣΤΑ ΧΩΝΕΥΤΑ Flushed in the wall Glazing -Insect Screen- Shutter

Sections Scale 1:1

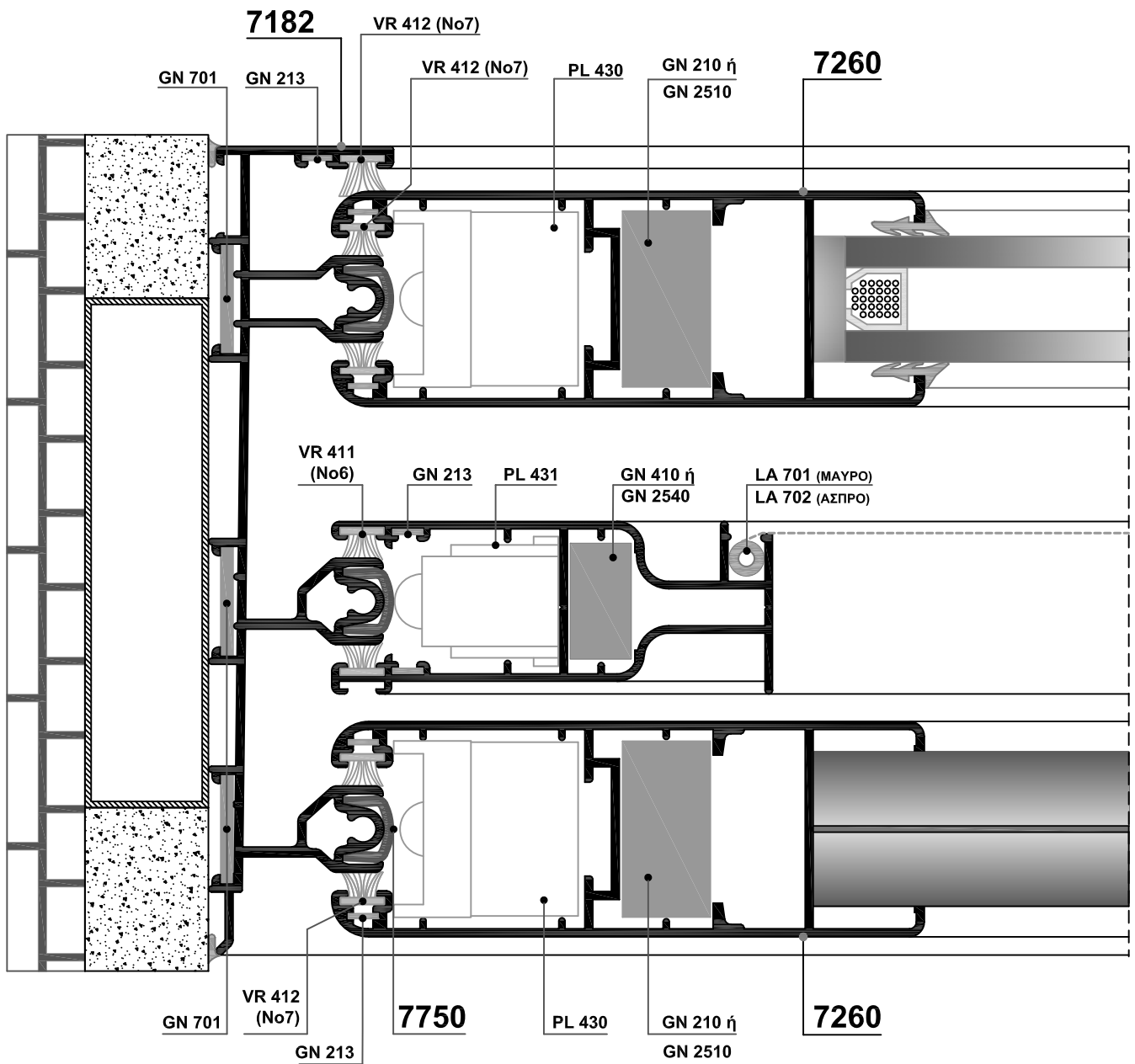
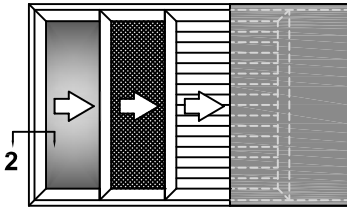

## ΤΖΑΜΙ - ΣΗΤΑ - ΠΑΤΖΟΥΡΙ ΑΝΤΙΚΡΙΣΤΑ ΧΩΝΕΥΤΑ Flushed in the wall Glazing -Insect Screen- Shutter

Sections

Scale 0.8:1

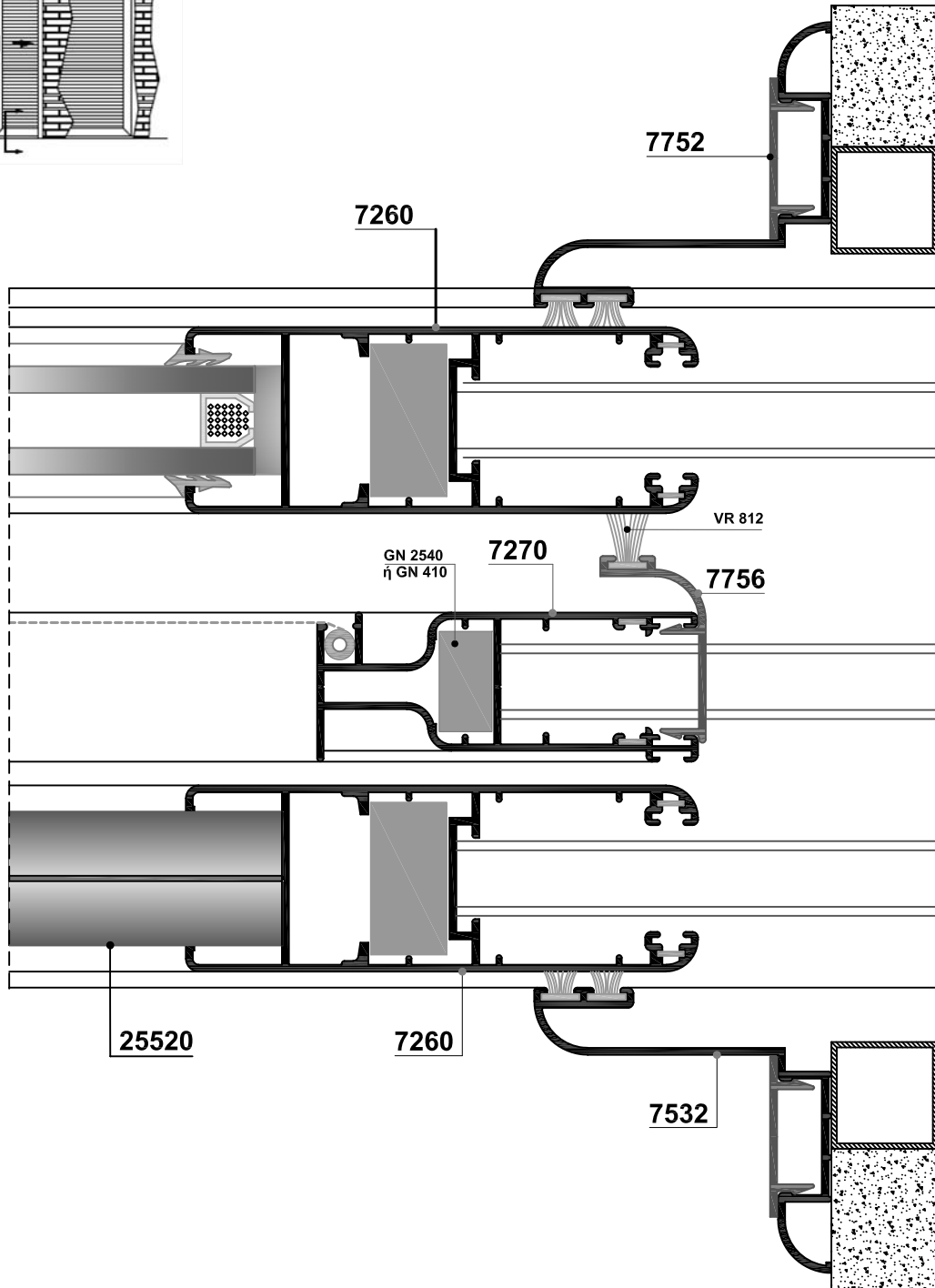
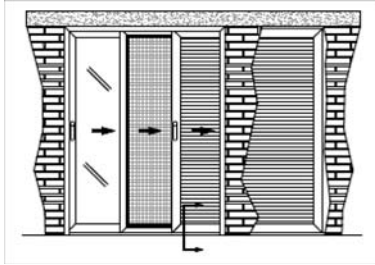

## ΚΟΠΕΣ Cutting Instructions

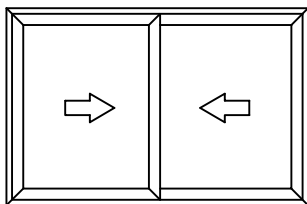

### ΔΙΦΥΛΛΟ ΕΠΑΛΛΗΛΟ Double sash overlapping ΟΔΗΓΟΣ (rail) 7171, 7181

**ΦΥΛΛΟ (sash) 7258, 7259**

$$\text{ΠΦ} = (\text{ΠΚ} + 41) / 2$$

**ΦΥΛΛΟ (sash) 7260, 7261**

$$\text{ΠΦ} = (\text{ΠΚ} + 54) / 2$$

ΠΚ = ΠΛΑΤΟΣ ΚΑΣΑΣ  
length of frame  
ΥΚ = ΥΨΟΣ ΚΑΣΑΣ  
height of frame  
ΠΦ = ΠΛΑΤΟΣ ΦΥΛΛΟΥ  
length of sash  
ΥΦ = ΥΨΟΣ ΦΥΛΛΟΥ  
height of sash

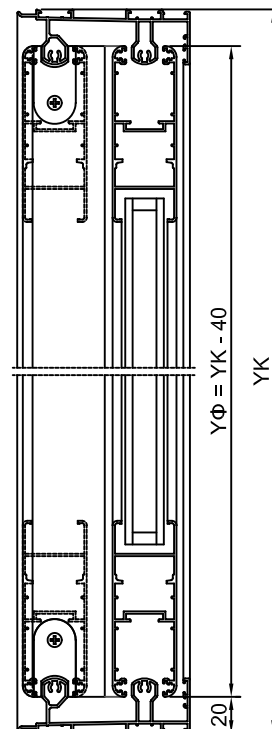
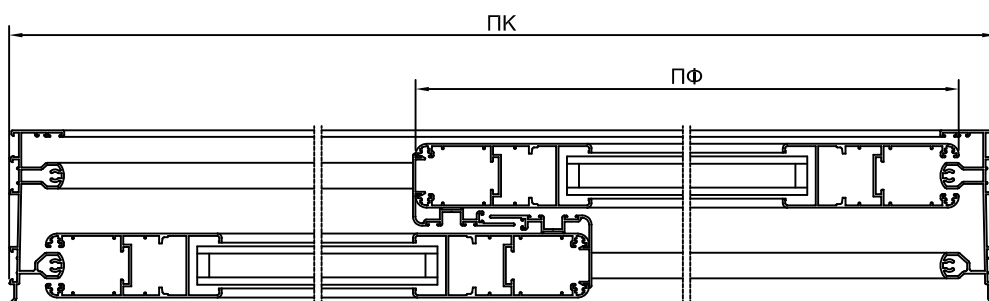

## ΚΟΠΕΣ Cutting Instructions

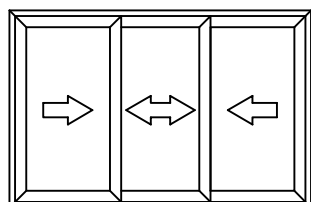

### ΤΡΙΦΥΛΛΟ ΕΠΑΛΛΗΛΟ Triple sash overlapping ΟΔΗΓΟΣ (rail) 7171, 7181

**ΦΥΛΛΟ (sash) 7258, 7259**

$$\text{ΠΦ} = (\text{ΠΚ} + 122) / 3$$

**ΦΥΛΛΟ (sash) 7260, 7261**

$$\text{ΠΦ} = (\text{ΠΚ} + 149) / 3$$

ΠΚ = ΠΛΑΤΟΣ ΚΑΣΑΣ  
length of frame  
ΥΚ = ΥΨΟΣ ΚΑΣΑΣ  
height of frame  
ΠΦ = ΠΛΑΤΟΣ ΦΥΛΛΟΥ  
length of sash  
ΥΦ = ΥΨΟΣ ΦΥΛΛΟΥ  
height of sash

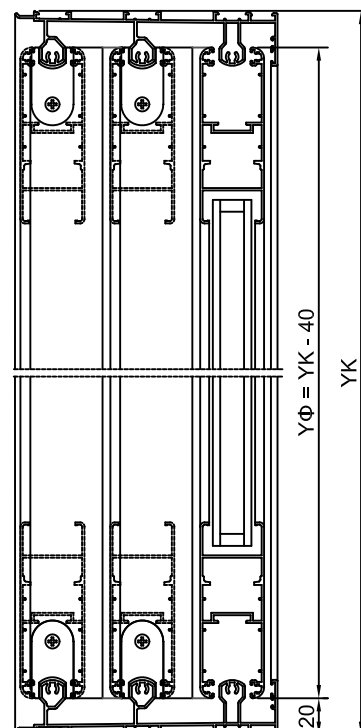
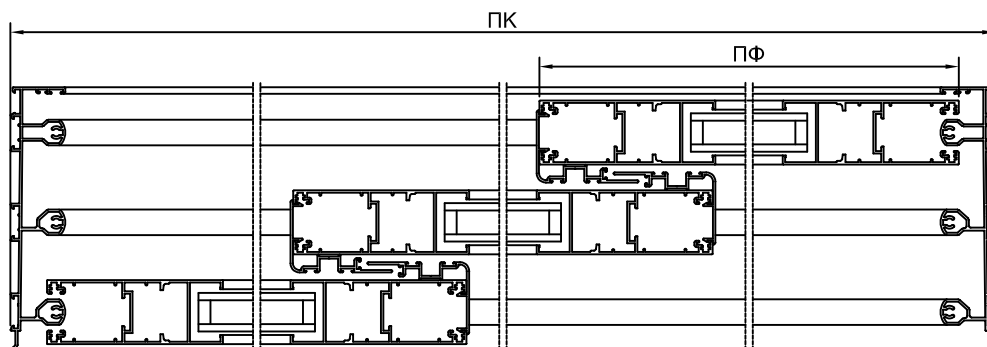

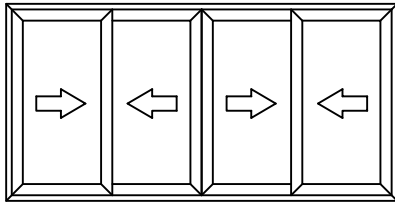

## ΤΕΤΡΑΦΥΛΛΟ ΕΠΑΛΛΗΛΟ four sash overlapping ΟΔΗΓΟΣ (rail) 7171, 7181

**ΚΟΠΕΣ**  
cutting  
instructions

ΠΚ = ΠΛΑΤΟΣ ΚΑΣΑΣ  
length of frame  
ΥΚ = ΥΨΟΣ ΚΑΣΑΣ  
height of frame  
ΠΦ = ΠΛΑΤΟΣ ΦΥΛΛΟΥ  
length of sash  
ΥΦ = ΥΨΟΣ ΦΥΛΛΟΥ  
height of sash  
ΥΜ = ΥΨΟΣ ΜΠΙΝΙ  
height of adaptor  
7634

**ΦΥΛΛΟ (sash) 7258, 7259**

$$\text{ΠΦ} = (\text{ΠΚ} + 115) / 4$$

**ΦΥΛΛΟ (sash) 7260, 7261**

$$\text{ΠΦ} = (\text{ΠΚ} + 142) / 4$$

$$\text{ΥΜ} = \text{ΥΚ} - 78$$

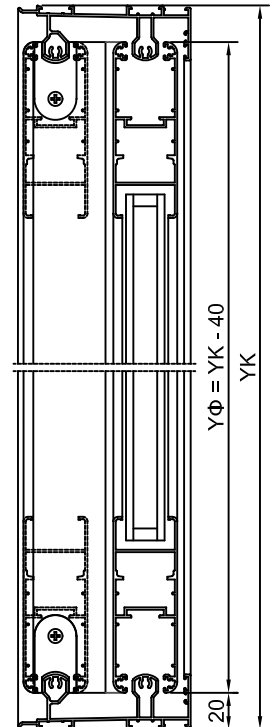
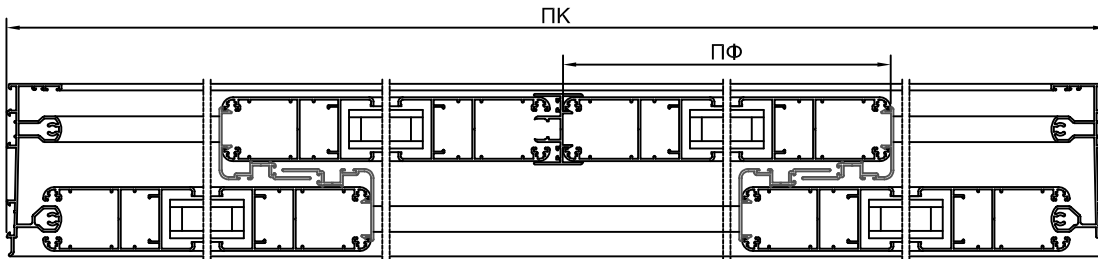

**ΚΑΤΕΡΓΑΣΙΕΣ**  
Machining

## ΣΥΝΔΕΣΗ ΟΔΗΓΩΝ ΜΕ ΤΙΣ ΓΩΝΙΕΣ GN 701 Track assembly with corners GN 701

ΧΡΗΣΙΜΟΠΟΙΗΣΤΕ ΜΟΝΟ  
ΦΡΕΖΑΤΕΣ ΒΙΔΕΣ!  
Use flat headed screws

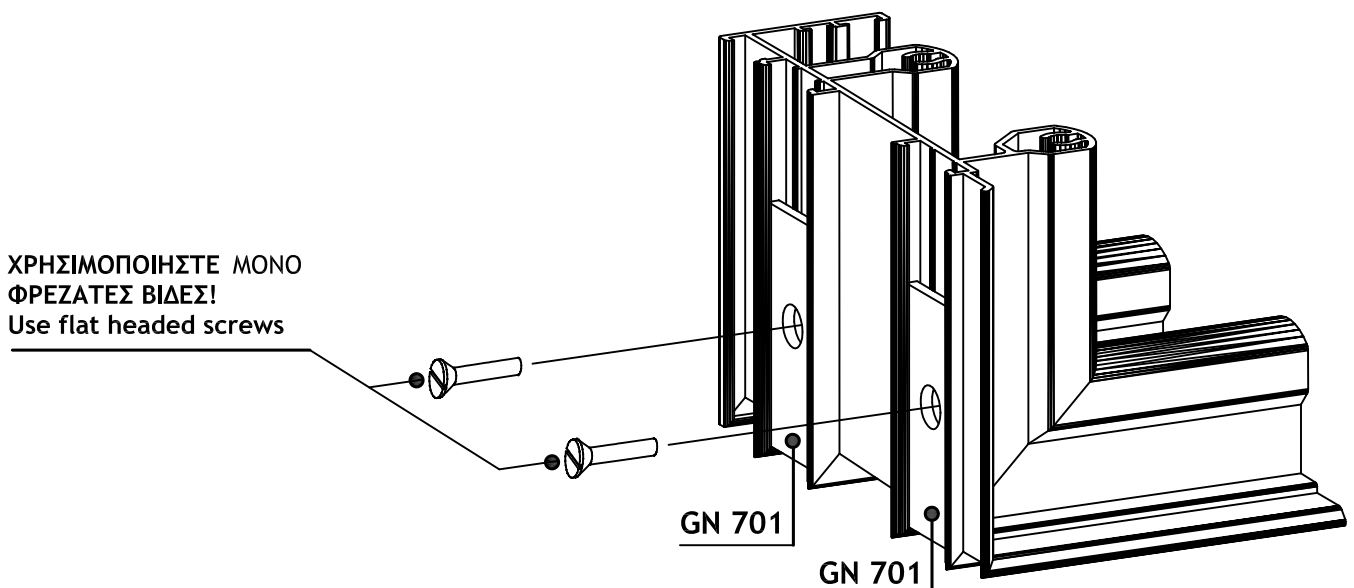

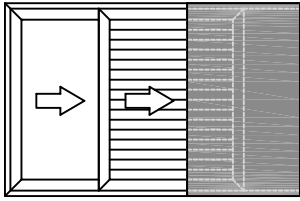

## ΤΖΑΜΙ - ΠΑΤΖΟΥΡΙ ΧΩΝΕΥΤΑ glass - shutter in the wall

**ΚΟΠΕΣ**  
cutting  
instructions

**ΟΔΗΓΟΣ (rail) 7171, 7181**

**ΦΥΛΛΟ (sash) 7258, 7259, 7260, 7261**

- ΠΚ = ΠΛΑΤΟΣ ΟΔΗΓΟΥ  
length of frame
- ΥΚ = ΥΨΟΣ ΚΑΣΑΣ  
height of frame
- ΠΦ = ΠΛΑΤΟΣ ΦΥΛΛΟΥ  
length of sash
- ΥΦ = ΥΨΟΣ ΦΥΛΛΟΥ  
height of sash

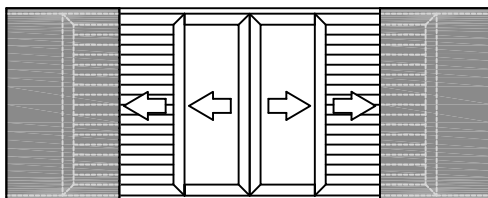
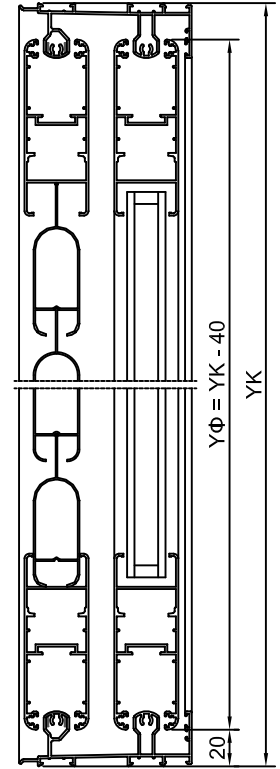
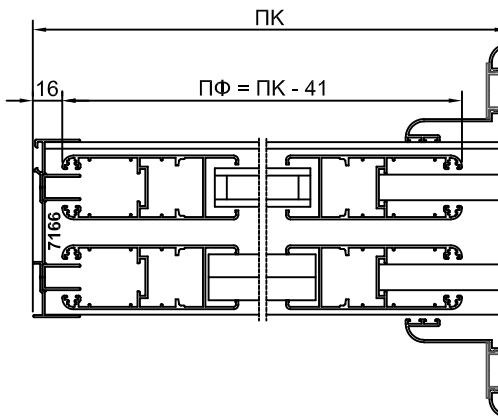
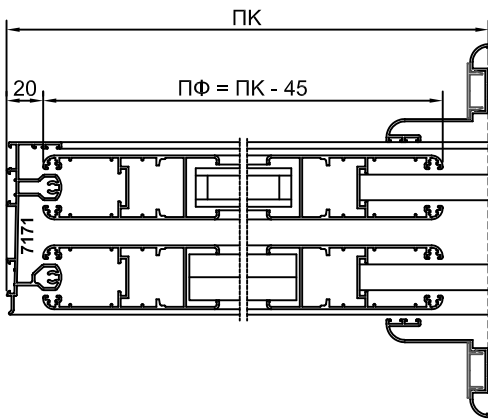

## ΤΖΑΜΙ - ΠΑΤΖΟΥΡΙ ΑΝΤΙΚΡΥΣΤΑ ΧΩΝΕΥΤΑ opposite glass - shutters in the wall

**ΟΔΗΓΟΣ (rail) 7171, 7181**

**ΦΥΛΛΟ (sash) 7258, 7259, 7260, 7261**

- ΠΚ = ΠΛΑΤΟΣ ΟΔΗΓΟΥ  
length of frame
- ΥΚ = ΥΨΟΣ ΚΑΣΑΣ  
height of frame
- ΠΦ = ΠΛΑΤΟΣ ΦΥΛΛΟΥ  
length of sash
- ΥΦ = ΥΨΟΣ ΦΥΛΛΟΥ  
height of sash
- ΥΜ = ΥΨΟΣ ΜΠΙΝΙ  
height of adaptor  
7634

$$\text{ΠΦ} = (\text{ΠΚ} - 57) / 2$$

$$\text{ΥΜ} = \text{ΥΚ} - 78$$

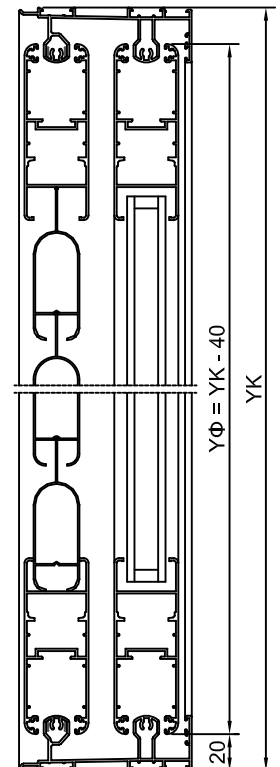
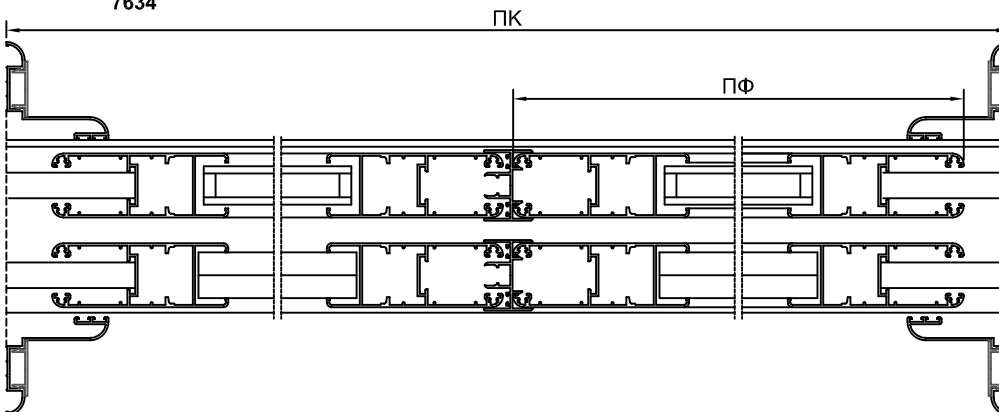

### GN 210

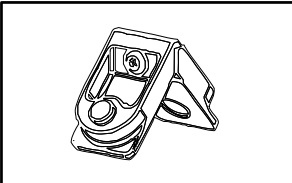

ΓΩΝΙΑ ΣΥΝΔΕΣΗΣ ΧΥΤΗ  
ΓΙΑ ΤΑ ΦΥΛΛΑ  
7258, 7259, 7260, 7261

cast corner  
bracket for sash  
7258, 7259, 7260, 7261

### GN 410

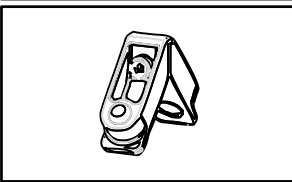

ΓΩΝΙΑ ΣΥΝΔΕΣΗΣ ΧΥΤΗ  
ΓΙΑ ΤΟ ΦΥΛΛΟ ΣΗΤΑΣ  
7270

cast corner bracket  
for insect screen  
frame 7270

### GN 701

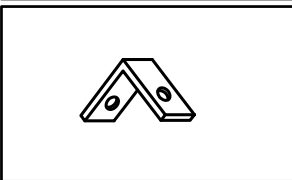

ΓΩΝΙΑ ΣΥΝΔΕΣΗΣ  
ΑΛΟΥΜΙΝΙΟΥ ΓΙΑ  
ΟΛΟΥΣ ΤΟΥΣ ΟΔΗΓΟΥΣ

aluminium corner  
bracket for all rails

### GN 860

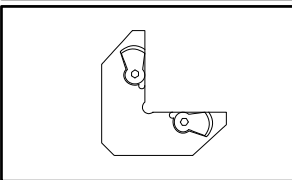

ΓΩΝΙΑ ΣΥΝΔΕΣΗΣ &  
ΕΥΘΥΓΡΑΜΜΙΣΗΣ  
7536, 8506

cast corner bracket for  
7536, 8506

### AC 421

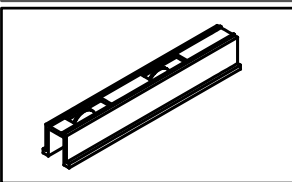

ΔΙΠΛΟ ΡΑΟΥΛΟ  
ΓΙΑ ΟΛΑ ΤΑ ΦΥΛΛΑ

double aluminium roller  
for all sashes

### AC 423

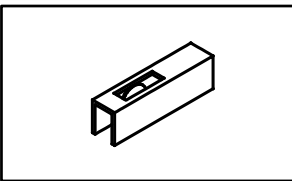

ΜΟΝΟ ΡΑΟΥΛΟ  
ΑΛΟΥΜΙΝΙΟΥ  
ΣΗΤΑΣ 7270

aluminium single  
roller for insect  
screen frame 7270

### AC 428

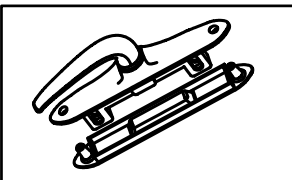

ΚΛΕΙΔΑΡΙΑ ΜΕ  
ΣΠΑΝΙΟΛΕΤΑ

espagnolette lock  
for sliding doors &  
windows

ΓΩΝΙΑ ΣΥΝΔΕΣΗΣ  
ΑΛΟΥΜΙΝΙΟΥ ΓΙΑ ΤΑ  
ΦΥΛΛΑ 7258, 7259, 7260,  
7261

aluminium corner  
bracket for sash  
7258, 7259, 7260, 7261

ΓΩΝΙΑ ΣΥΝΔΕΣΗΣ ΑΛΟΥ-  
ΜΙΝΙΟΥ ΓΙΑ ΤΟ ΦΥΛΛΟ  
ΣΗΤΑΣ 7270

aluminium corner  
bracket for insect  
screen frame 7270

ΓΩΝΙΑ ΕΠΙΠΕΔΟΤΗΤΑΣ  
ΓΑΛΒΑΝΙΖΕ 5 mm

alignment corner 5 mm

ΜΟΝΟ ΡΑΟΥΛΟ  
ΓΙΑ ΟΛΑ ΤΑ ΦΥΛΛΑ

single aluminium roller  
for all sashes

ΤΕΤΡΑΠΛΟ ΡΑΟΥΛΟ  
ΓΙΑ ΟΛΑ ΤΑ ΦΥΛΛΑ

quadruple aluminium  
roller for all sashes

ΚΛΕΙΔΑΡΙΑ ΧΩΝΕΥΤΗ

lock for sliding  
doors & windows

ΧΟΥΦΤΑ

handle for sliding  
doors & windows

### GN 2510

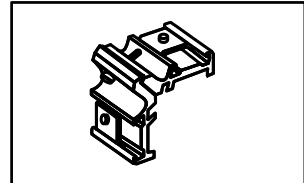

### GN 2540

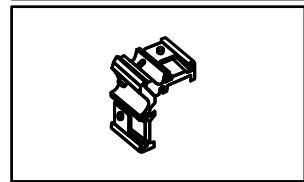

### GN 213

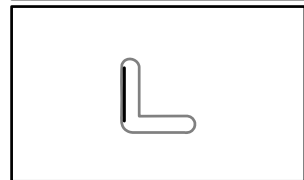

### AC 420

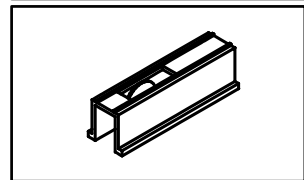

### AC 422

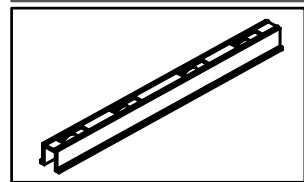

### AC 426

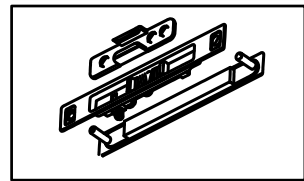

### AC 427

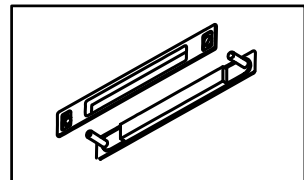

## ΕΞΑΡΤΗΜΑΤΑ accessories

### AC 429

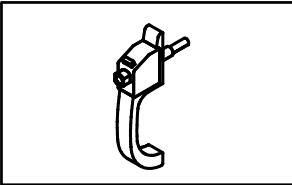

ΜΠΟΥΤΟΝ

button operated  
safety lock

### AC 610

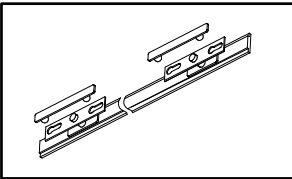

ΝΤΙΖΑ ΜΕ ΚΙΤ 4  
ΚΛΕΙΔΩΜΑΤΩΝ ΓΙΑ  
ΠΑΡΑΘΥΡΑ

safety multiple  
locking rod for  
windows

### AC 611

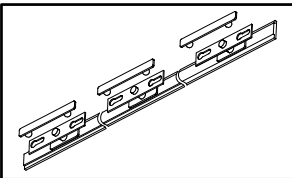

ΝΤΙΖΑ ΜΕ ΚΙΤ 6  
ΚΛΕΙΔΩΜΑΤΩΝ ΓΙΑ  
ΜΠΑΛΚΟΝΟΠΟΡΤΕΣ

safety multiple  
locking rod for  
doors

### AC 612

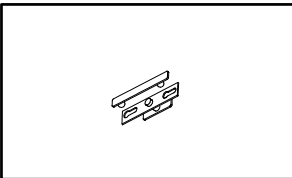

ΚΙΤ ΚΛΕΙΔΑΡΙΑΣ ΜΟΝΟ

kit for single-point lock

### PL 701

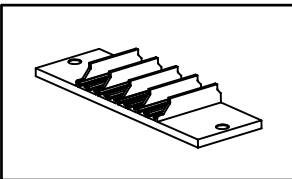

ΤΑΚΟΣ ΣΤΕΓΑΝΩΣΗΣ  
ΕΠΑΛΛΗΛΟΥ ΓΙΑ ΦΥΛΛΑ  
7260, 7261, 7268, 7269

head & sill weather  
seal for 7260, 7261, 7268,  
7269

### PL 430

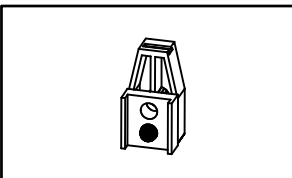

ΑΜΟΡΤΙΣΕΡ ΦΥΛΛΩΝ

plastic buffer for  
sash

### PL 431

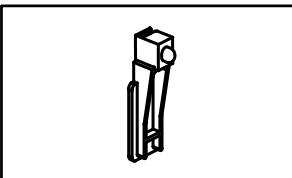

ΑΜΟΡΤΙΣΕΡ ΣΗΤΑΣ  
ΦΥΛΛΟΥ 7270

plastic buffer for  
insect screen frame  
7270

ΠΛΑΣΤΙΚΗ ΤΑΠΑ  
ΓΑΝΤΖΟΥ

top & bottom plastic  
plug for hook profile

ΠΛΑΣΤΙΚΗ ΤΑΠΑ ΜΠΙΝΙΟΥ  
ΑΝΤΙΚΡΥΣΤΩΝ ΦΥΛΛΩΝ  
(ΣΕΤ)

top & bottom plastic  
plug for adaptor (set)

ΠΛΑΣΤΙΚΗ ΤΑΠΑ ΜΠΙΝΙΟΥ  
ΑΝΤΙΚΡΥΣΤΩΝ ΦΥΛΛΩΝ  
ΣΗΤΑΣ

top & bottom plastic  
plug for adaptor  
insect screen frame

ΤΑΚΟΣ ΣΤΕΓΑΝΩΣΗΣ  
ΕΠΑΛΛΗΛΟΥ ΓΙΑ ΦΥΛΛΑ  
7258, 7259

head & sill weather  
seal for 7258, 7259

ΑΝΟΞΕΙΩΤΟ ΛΑΜΑΚΙ  
ΟΔΗΓΩΝ

inox cap for rails

ΣΤΟΠΕΡ ΑΝΤΙΚΡΥΣΤΩΝ  
ΦΥΛΛΩΝ (ΦΙΛΗΤΑ)

stopper for opposite  
sashes

ΑΜΟΡΤΙΣΕΡ ΦΥΛΛΟΥ  
ΡΥΘΜΙΖΟΜΕΝΟ

adjustable plastic buffer  
for sash

### PL 140

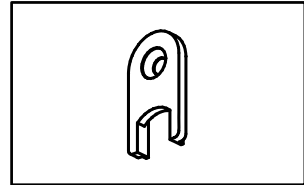

### PL 624

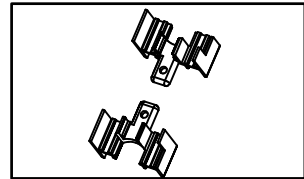

### PL 434

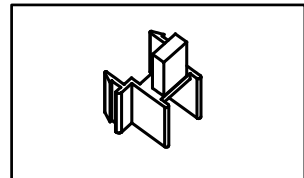

### PL 700

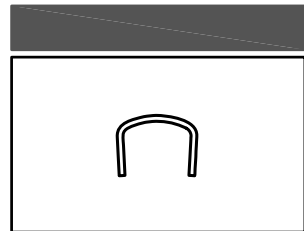
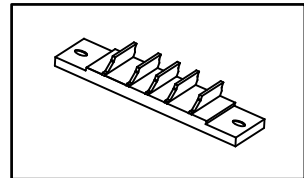

### SL 81

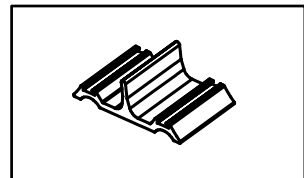

### PL 626

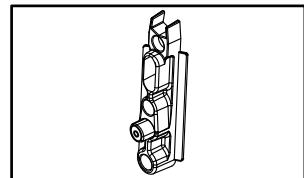



## ΕΞΑΡΤΗΜΑΤΑ accessories

**VR 411**

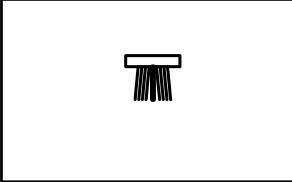

ΒΟΥΡΤΣΑΚΙ ΣΤΕΓΑΝΟΠ.  
No 6

weatherstripping brush  
No 6

**VR 412**

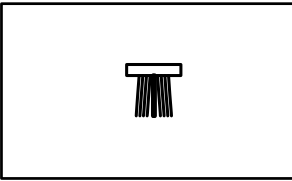

ΒΟΥΡΤΣΑΚΙ ΣΤΕΓΑΝΟΠ.  
No 7

weatherstripping brush  
No 7

**LA 201**

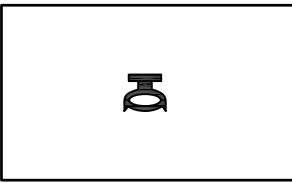

ΦΟΥΣΚΑΚΙ

rubber seal

ΒΟΥΡΤΣΑΚΙ ΣΤΕΓΑΝΟΠ.  
ΜΕ ΜΕΜΒΡΑΝΗ  
No 6

weatherstripping brush  
with membrane, No 6

ΒΟΥΡΤΣΑΚΙ ΣΤΕΓΑΝΟΠ.  
ΜΕ ΜΕΜΒΡΑΝΗ  
No 7

weatherstripping brush  
with membrane, No 7

ΛΑΣΤΙΧΟ ΣΗΤΑΣ

rubber rod for  
screen mesh

**VR 610**

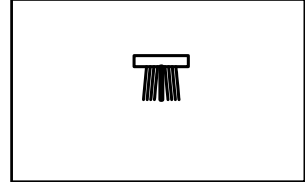

**VR 611**

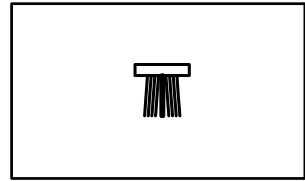

**LA 701**

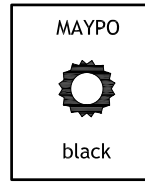

**LA 702**

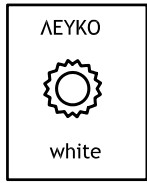

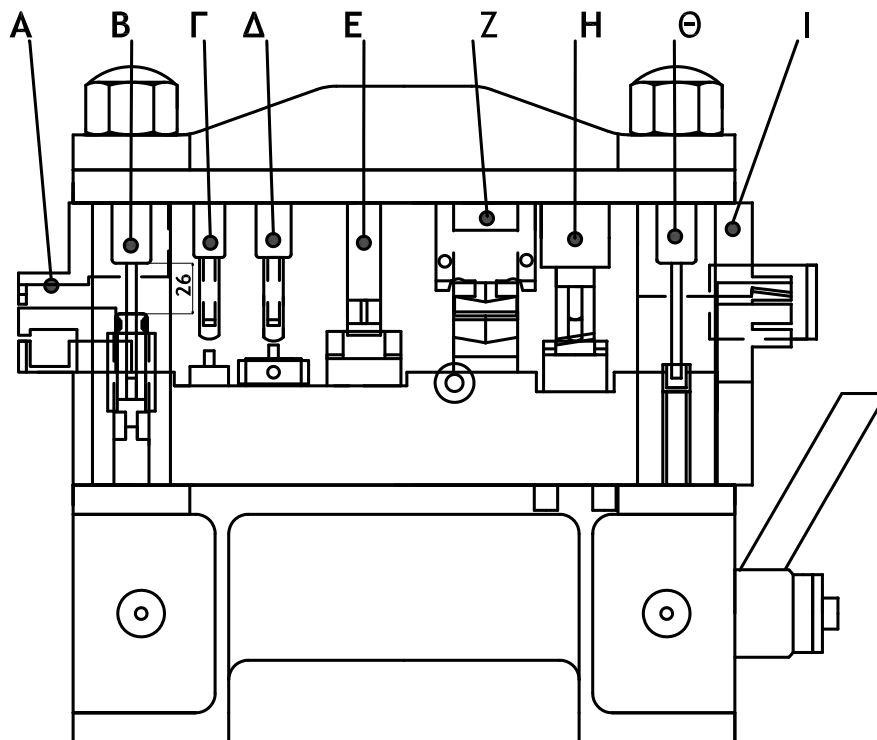
ΠΡΕΣΑΚΙ ΣΥΡΟΜΕΝΩΝ / Punching machine for sliding systems

- A. ΤΡΥΠΗΤΙΚΟ ΝΕΡΟΧΥΤΗ ΚΑΤΩ ΟΔΗΓΟΥ / cutting tool for low rail drain hole  
 Β. ΤΡΥΠΗΤΙΚΟ ΓΙΑ ΓΩΝΙΑΣΜΑ ΟΔΗΓΩΝ / perforator of rail for aluminium corner GN 417  
 Γ. ΤΡΥΠΗΤΙΚΟ ΓΩΝΙΑΣ ΣΥΝΔΕΣΗΣ ΣΗΤΑΣ / perforator for corner bracket of mosquito screen frame  
 Δ. ΤΡΥΠΗΤΙΚΟ ΓΩΝΙΑΣ ΣΥΝΔΕΣΗΣ ΦΥΛΛΩΝ / perforator for corner bracket of sash profile  
 Ε. ΤΡΥΠΗΤΙΚΟ ΤΑΠΑΣ ΓΑΝΤΖΟΥ / perforator of hook profile SLIM 140 for plastic plug  
 Ζ. ΞΕΛΟΥΡΙΣΤΙΚΟ ΓΙΑ ΣΟΚΟΡΟ / cutting tool forsashes 4515, 4515A, 4516 and 4516A  
 Η. ΤΡΥΠΗΤΙΚΟ ΤΑΠΑΣ ΓΙΑ ΣΟΚΟΡΟ / perforator for hook profiles's 4515 & 4515A plastic plug  
 Θ. ΤΡΥΠΗΤΙΚΟ ΠΛΑΪΝΟΥ ΟΔΗΓΟΥ ΓΙΑ ΣΟΚΟΡΟ / perforator for fixing screws on vertical runner  
 Ι. ΞΕΝΕΥΡΩΜΑ ΠΛΑΪΝΟΥ ΟΔΗΓΟΥ / cutting tool for assembly of vertical runner with rail



**[www.metaloumin.gr](http://www.metaloumin.gr)**  
**Tel: +30 210 24 63 630**  
**Fax: +30 210 24 64 471**  
**ΑΓ. ΦΑΝΟΥΡΙΟΥ 20, 136 71 ΑΧΑΡΝΕΣ**  
**GREECE**

**[www.metaloumin.gr](http://www.metaloumin.gr)**  
**Τηλ: 210 24 63 630**  
**Fax: 210 24 64 471**  
**ΑΓ. ΦΑΝΟΥΡΙΟΥ 20, 136 71 ΑΧΑΡΝΑΙ**